



# ellia

## ASPIRE

ARM-1210

Create your perfect environment with Ellia Essential Oils and Diffusers.

Our beautiful diffusers gently lift the aroma of Ellia Essential Oils into the air to help you reduce stress, boost mental clarity, and soothe your body and mind. Ellia Diffusers are beautiful, functional centerpieces that add natural style to your home.



### REGISTER YOUR DIFFUSER

Registering your diffuser secures the benefits of your warranty (even if you lose your receipt). It also makes it easier for us to assist you if you ever have an issue with your product.

[www.homedics.com/product-registration](http://www.homedics.com/product-registration)

### PARTS AND PIECES

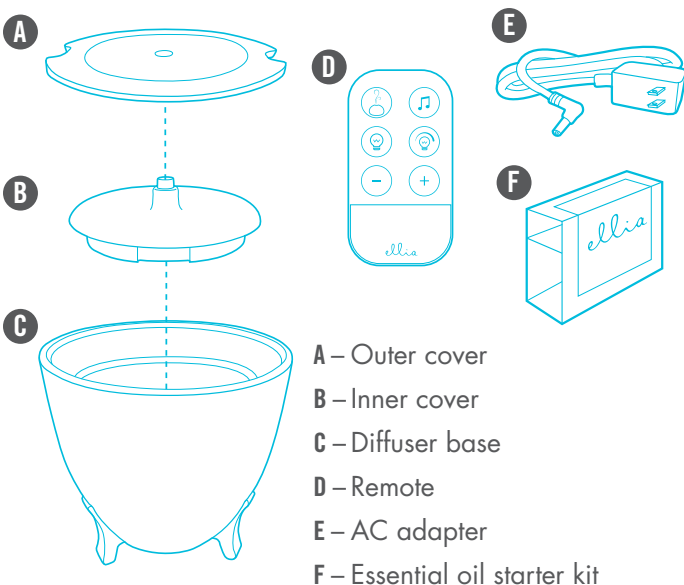

### UNIQUE FEATURES AND SPECIFICATIONS

#### Ultrasonic Technology

This diffuser uses ultrasonic, high-frequency technology to convert the water and essential oil into a fine mist that is dispersed into the air evenly, delivering natural aroma to enhance your mood.

#### Color-Changing Light

The gentle glow creates a peaceful environment. Choose your desired color to best match your mood.

#### Relaxing and Uplifting Sounds

Quiet your mind or boost your energy.

#### Runtime

Up to 10 hours of continuous runtime or 20 hours of intermittent runtime.

#### Soothing Humidity

Alleviates dry air.

#### Auto Shut-Off Protection

When the reservoir is empty, the unit will shut off automatically.

#### Reservoir Capacity

200 ml

#### Adapter Voltage

100 - 240V 50/60Hz

## HOW TO USE AND DIFFUSE

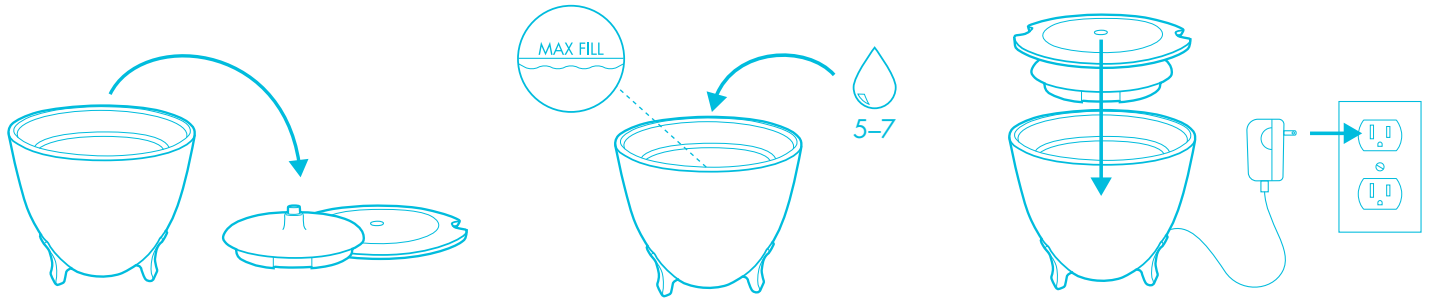

1. Remove the outer cover from the base. Next, remove the inner cover.
2. Pour water into the reservoir until it reaches the max fill line, then add 5-7 drops of essential oil to the water. Depending on your personal preference, you may add more or fewer drops of essential oil.
3. Put the inner and outer covers back on.
4. Plug the adapter into the diffuser, then plug the adapter into an outlet. Use caution when plugging the unit in to avoid spilling water and essential oil.
5. Choose your aroma mist, light, and sound options.



### Remote

Your remote uses a CR2025 Lithium 3V Battery. Make sure to remove the pull tab before use.



- A – Aroma mist button
- B – Music button
- C – Light button
- D – Light brightness
- E – Volume down
- F – Volume up



### Aroma Mist

Your diffuser has two mist options. Press  once for continuous mist, which will run for up to 10 hours. Press again for intermittent mist (30 seconds on, 30 seconds off), which will run for up to 20 hours. Press a third time to turn the mist off. Press and hold  to turn the diffuser off. When your diffuser runs out of water, it will automatically shut off.

### Color-Changing Light

Press  or  once to turn on the color-changing light. Press again to stop on a preferred color. Press a third time to turn the light off. Press and hold at any time to turn the light off.

### Light Brightness

While the light is on, press  once for medium light. Press again for low light. Press a third time for bright light.

### Relaxing and Uplifting Sounds

Press  once to play the first track. Press again to switch to the next track. Press and hold to turn the music off.

### Power Button

Press  once for continuous mist. Press again for intermittent mist. Press a third time to turn the mist off. Press and hold to turn the diffuser off.

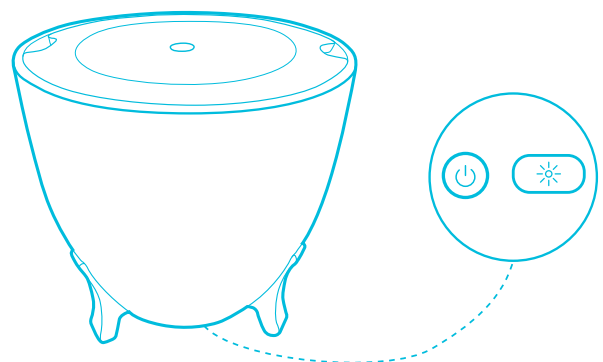

### ESSENTIAL OILS

Visit us online to stock up on your favorite Ellia Essential Oils, including our single notes and signature blends.

[www.ellia.com](http://www.ellia.com)

## CLEANING AND CARE

1. Before cleaning the unit, turn the power off and make sure the adapter is unplugged from the diffuser and outlet.
2. Remove the outer cover from the base. Next, remove the inner cover.
3. Carefully pour any remaining water and essential oil out of the reservoir, from the drain side, opposite the air outlet. Be sure not to empty the reservoir near the air outlet in order to avoid malfunction.

### To Clean the Surface

Clean the surface of your diffuser with a clean, damp, soft cloth as often as needed.

### To Clean the Reservoir and Ultrasonic Membrane

We recommend wiping the reservoir with a clean, damp, soft cloth at least once every 2 weeks.

**NOTE:** Depending on your usage, and the amount of essential oil you use, you may want to clean the reservoir and ultrasonic membrane more frequently for best performance.

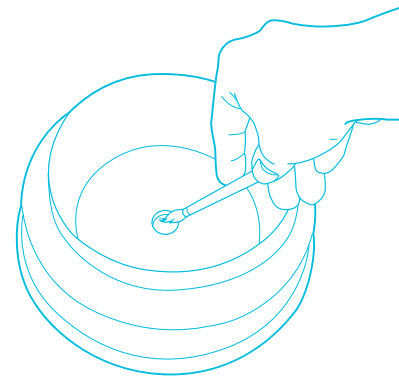

For the most thorough clean, pour a 50/50 mixture of vinegar and water into the reservoir, then soak for five minutes. Brush reservoir walls, base, and ultrasonic membrane clean with a soft-bristle brush (not included) and rinse. NEVER touch the ultrasonic membrane with your fingers, as the natural oils in skin can damage the membrane.

Clean the membrane once every two to three weeks, depending on your usage.

Clean and dry the unit before extended periods of inactivity.

## GET STARTED WITH THE ELLIA APP

Download the Ellia app in the iTunes or Google Play store, then install the app on your device.



Enable *Bluetooth* on your device. Connect and activate your aroma diffuser.



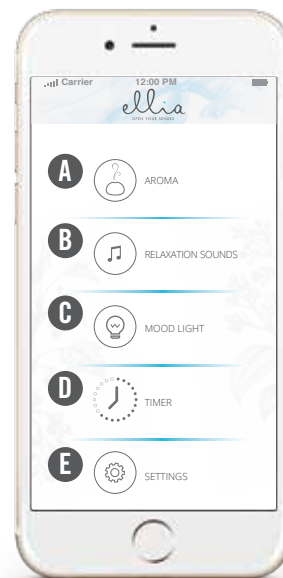

### Home Screen

From the home screen, choose which feature you would like to control or customize. Remember to first turn on your diffuser by using the remote or pressing the power button on the bottom of the unit.

- A – Aroma mist output
- B – Relaxation sounds
- C – Mood light
- D – Timer
- E – Settings

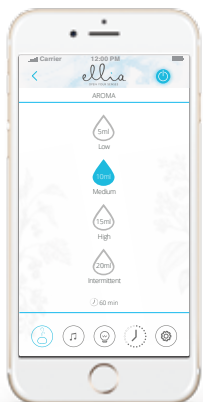

### Aroma Mist Output

Choose your desired mist output setting. The power button turns the mist on and off.

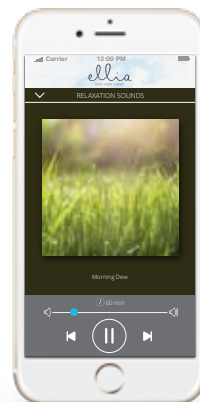

### Relaxation Sounds

Choose your desired sound and adjust the volume to your liking. Skip to different sounds to match your mood.



### Mood Light

Press  once to turn on the color-changing light. Choose your desired color and brightness of light. Tap the camera icon to access the camera match screen.

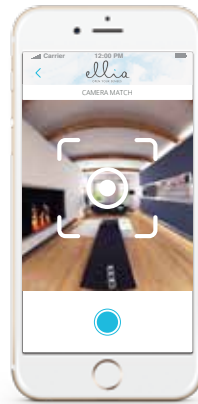

### Camera Match

Point and shoot your camera at a color from your surroundings. That color will be matched through your mood light.



### Timer

Choose the runtime for your diffuser. It will automatically shut off when the time has elapsed.

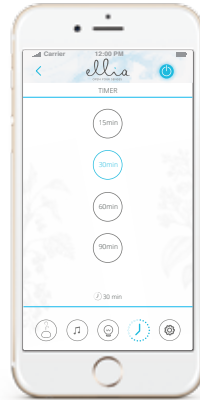

### Settings

Access additional information about Ellia Aroma Diffusers and Essential Oils.

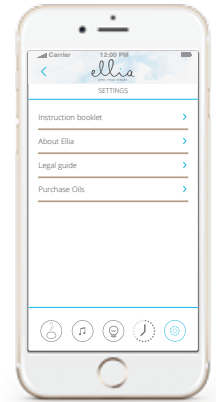

## TROUBLESHOOTING

Problem	Possible Cause	Solution
No mist	Power supply is not connected	Plug the adapter in and press the power button
	Insufficient water	Refill the water reservoir
	Water is exceeding the max fill line	Dump the excess water out of the reservoir
	The ultrasonic membrane is clogged with essential oil buildup	Clean the membrane by following the aforementioned instructions
Remote not working	Dead battery	Replace the battery (CR2025 Lithium 3V)



### THE ELLIA™ FAMILY

Our range of eco-inspired products are designed to complement your lifestyle and decor. Once you try an Ellia diffuser, you'll want one for every room in your home. Add to your own Ellia collection or buy a thoughtful gift for someone.

Browse the entire product family at [www.ellia.com](http://www.ellia.com).

### CONTACT US

Questions or concerns? We're here to help. Contact a Consumer Relations representative by phone or email to help answer any questions. Please be sure to have the model number of your product available.

#### For Service in the USA

email: [cservice@ellia.com](mailto:cservice@ellia.com)

phone: 248.863.3160

Monday to Friday, 8:30am - 7:00pm EST

#### For Service in Canada

email: [cservice@homedicsgroup.ca](mailto:cservice@homedicsgroup.ca)

phone: 1.888.225.7378

Monday to Friday, 8:30am - 5:00pm EST



## ONE YEAR LIMITED WARRANTY

For detailed warranty instructions, visit: [www.ellia.com](http://www.ellia.com)

To obtain warranty service on your Ellia product, contact a Consumer Relations Representative by the telephone number or email address for your country of residence. Please make sure to have the model number of the product available.

### For Service in the USA

email: [cservice@ellia.com](mailto:cservice@ellia.com)

phone: 248.863.3160

Monday to Friday, 8:30am - 7:00pm EST

### For Service in Canada

email: [cservice@homedicsgroup.ca](mailto:cservice@homedicsgroup.ca)

phone: 1.888.225.7378

Monday to Friday, 8:30am - 5:00pm EST

## FCC AND IC STATEMENTS

This device complies with part 15 of the FCC Rules. Operation is subject to the following two conditions: (1) This device may not cause harmful interference, and (2) this device must accept any interference received, including interference that may cause undesired operation.

This equipment has been tested and found to comply with the limits for a Class B digital device, pursuant to part 15 of the FCC Rules and ICES 003. These limits are designed to provide reasonable protection against harmful interference in a residential installation.

This equipment generates, uses and can radiate radio frequency energy and, if not installed and used in accordance with the instructions, may cause harmful interference to radio communications.

However, there is no guarantee that interference will not occur in a particular installation.

If this equipment does cause harmful interference to radio or television reception, which can be determined by turning the equipment off and on, the user is encouraged to try to correct the interference by one or more of the following measures:

- Reorient or relocate the receiving antenna.
- Increase the separation between the equipment and receiver.
- Connect the equipment into an outlet on a circuit different from that to which the receiver is connected.
- Consult the dealer or an experienced radio/TV technician for help.

Changes or modifications not expressly approved by HoMedics could void the user's authority to operate this equipment.

This product has been tested and complies with the requirements for Federal Communication Commission, Part 18 and ICES 001. Although this product is tested and complies with FCC, it may interfere with other devices. If this product is found to interfere with another device, separate the other

device and this product. Conduct only the user maintenance found in this instruction manual. Other maintenance and servicing may cause harmful interference and can void the required FCC compliance.

## IMPORTANT SAFETY INSTRUCTIONS

**WHEN USING ELECTRICAL PRODUCTS, ESPECIALLY WHEN CHILDREN ARE PRESENT, BASIC SAFETY PRECAUTIONS SHOULD ALWAYS BE FOLLOWED, INCLUDING THE FOLLOWING:**

### READ ALL INSTRUCTIONS BEFORE USING

- Always place diffuser on a firm, flat surface. A waterproof mat or pad is recommended for use under the diffuser. Never place it on a rug or carpet, or on a finished floor that may be damaged by exposure to water or moisture.
- Always unplug the unit from the electrical outlet immediately after using and before cleaning
- DO NOT reach for a unit that has fallen into water. Unplug it immediately.
- DO NOT place or drop into water or other liquids.
- DO NOT use water above 86° Fahrenheit.
- Use this unit only for its intended use as described in this document, the quick start guide and user guide.
- Do not use attachments not recommended by Ellia or HoMedics; specifically any attachments not provided with this unit.
- NEVER drop or insert any object into any opening.
- DO NOT place the diffuser near heat sources, such as a stove.
- Always keep the cord away from high temperature and fire.
- To disconnect, turn unit off, then remove the plug from the outlet.
- DO NOT use outdoors. For indoor use only.
- Never cover the unit while it is operating.
- If the cord sustains damage, you must stop using this product immediately and contact Ellia consumer relations (see Warranty section for consumer relations contact information).
- Perform regular maintenance on the ultrasonic membrane.
- Never use detergent to clean the ultrasonic membrane.
- Never clean the ultrasonic membrane by scraping with a hard object.
- Do not attempt to adjust or repair the unit. Servicing must be performed by professional or qualified personnel.
- Stop using this unit if there is an unusual noise or smell.
- Unplug this unit when not in use for a long period of time.
- Do not touch the water or any parts of the unit that are covered by water while the unit is on or plugged in.
- Do not wash, adjust, or move this unit without first unplugging it from the electrical outlet.
- Keep this unit out of reach of children.

### Attention California Residents:

**WARNING: This product contains chemicals known to the State of California to cause cancer, birth defects and other reproductive harm.**